

AVANZ



NEWS

Newsletter of the Vintage Special Interest Group of Model Flying New Zealand #186





COMMITTEE NOTICES



In this Issue

Committee Notes

Future Events

Past Events

Letter to the Editor

E-Rubber Battery chart

Classic Power by Jim Clem

- *Witch Doctor 1968*

- *Okie Bird 1975*

- *Fire Wagon 1971*

It was 10 Years Ago, Today

F.Bethwaite's Record

Wakefield Cup 1934

Hints

Vintage Rubber

- *Le Vibrant*

Zaic Yearbook

Real Vintage

Real Vintage

Readers' Models

Nostalgia Power

- *Hot Rod 1957*

- *Cardinal 1951*

Aeromodelling Book

Neighbours

Leader Boards

Cover Stories

Miscellaneous

Easier Rules Full Vintage rules are available from the MFNZ website and can be downloaded as a PDF to be kept on your computer for reference (up-date your copy every year). Go to modelflyingnz.co then to SIGs / Vintage. With so many events, scrolling up and down can be tiresome, so use of the rules has been made easier and quicker by the addition of internal links. These are in blue and by clicking on links you will be taken to the appropriate section. For example, click on [5.3](#) on the first page list of events and you will jump to rules for [Open Texaco](#). In any section of the rules, click on [Return to top](#) to select another area of the rules.

Vintage Championship Review of the VC contest format, which was trialled over the first half of this year, has led to a Committee decision to not repeat it in 2022. The Championship failed generate the support that was expected, and there was a wide feeling that the previous regional contests, along with the NDC programme and Nationals, are sufficient for our competition needs.

Survey To customise the running of Vintage events to what is wanted, a survey will soon be emailed to NZ readers. Take a few moments to tick the boxes and to comment on what you like and don't like. Don't be too coy or lazy to make your opinions known - not sharing your thoughts will deny organisers the chance to tailor events for the greatest appeal.

Nationals

Vintage AGM is on Mon 3rd combined with a BBQ starting at 5:45pm near the Hall at HQ,

Vintage Prize-giving is on Friday 7th at 2:30pm in the Vintage Car Clubrooms

Contributors to this Issue

Wayne Cartwright

Paul Lagan

Allan Knox

Graham Main

Barrie Russell

AndyDodson

Barry Hall

Peter Townsend

Peter Lehane

Randy Crumble

Mark Beecroft

Cover Logo

Doug Baunton's PB-2 before Mt Egmont. Photo by Andy Dodson
Chocolate Fish (see Miscellaneous page)

SIG CHAIRMAN SIG SECRETARY MFNZ COLUMN COMMITTEE

Don Mossop donmossop@gmail.com

Don Mossop donmossop@gmail.com

W Cartwright and D Crook chloecat@xtra.co.nz

Wayne Cartwright rwcartwright4@gmail.com

Bryan Treloar bryan_treloar@hotmail.com Warner Summerton gsumm@gmail.com

Peter Townsend petert2@hotmail.com Allan Knox allan.j.knox@gmail.com

Barrie Russell barrierussell@xtra.co.nz

TREASURER

Jan Butcher jjbutcher@xtra.co.nz

AVANZ PLANS

Mark Venter avanz.plans@xtra.co.nz

AVANZ News

Bernard Scott scott.scott@xtra.co.nz

Tony Gribble agrib@orcon.net.nz

~~September 25~~
John Selby Memorial

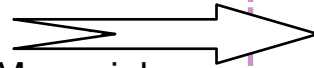

October 23 - 24 2021
Tuakau MAC

November 20 - 21 2021
Thames Blackfeet

December 2021
No contest flying

January 03 - 07 2022
Nationals Carterton

February 26 - 27 2022
Airsail MAC

March 12 - 13 2022
Awatoto (TBC)

April 9 - 10 2022
Thames Blackfeet

May 21 - 22 2022
Tuakau MAC

John Selby Memorial Vintage Event has been POSTPONED to Saturday 9 October

In addition to the forecast of increasing nor-westerly winds that will make flying difficult as the day develops, cattle have broken through the electric fence and caused damage to the Levin strip and pits area. We have therefore decided the best course is to postpone the event which will now be held on our wind date of Saturday 9 October. The club has advised they will have the area rolled and back to its normal excellent condition for our revised date. All clubs are welcome and both competition and sport vintage flying are encouraged. This is a one day event on Saturday 9th only.

COVID - Please ensure you respect Level 2 Covid rules, in particular ensure you scan the QR code or sign in at the club house and observe social distancing. Unfortunately we can't BBQ under L2 so please bring your own lunch. It would also be helpful if you kept a pen in your pocket on the day to write down scores rather than using a communal pen.

CD - Bryan Treloar will be CD on the day.

I hope to attend but have had some recent health issues so may or may not be able to be there.

WEATHER - Bryan and I will make a weather call on Friday afternoon and advise to this email group at that time whether the event will take place this Saturday 25 September as planned or be postponed to the wind date of Saturday 9 October.

EVENT DETAILS

- Saturday 25 September - RC Starts 9.30am both days (FF earlier if you wish)
- RC - Fly any RC Vintage or RC Classical Class or Sport Fly. Competition is low key.
- Free Flight: Note we are also going to include a small field vintage free flight event for those interested. While you can fly whatever Vintage FF class you wish, it is suggested that we fly Vintage Precision and Vintage CAT
- No entry fees - Levin MAC, Tararua Road (Cross railway line from SH1 by Allied Fuel Station on south side of town, turn right towards Mainfreight and follow road past "JB's for #2's & firewood" and Trayla. Flying site and club house is on the right with gate about 100 metres beyond the road signs for the change in speed limit)

If our email on Friday confirms the event is proceeding but you are unsure about weather on the day, consult the Levin MAC weather station at <https://holfuy.com/en/weather/1073> rather than making a call based on your local Weather. Levin has a much better microclimate for model flying than anywhere else in the lower North Island west of the main divide. Feel free to ring the organisers if unsure.

If you have questions about any aspects of the event, please don't hesitate to contact one of the joint organisers - Stew Cox (027 548 1894) or Bryan Treloar (0204 147 6917). Hope to see you there. We are aware of at least two new vintage models that will be flown at the event, hopefully you have also been busy over lockdown!

Kind regards, Stew and Bryan



2022 NATIONALS - Vintage Programme

DON'T
OVERLOOK
THIS BIT...



...RIGHT
DOWN
HERE...



...AT THE
BOTTOM..



...ALMOST
THERE...

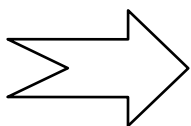

FFV01	FF Vintage Power	FF	Mon Jan 3 - 7:00 am	Mon Jan 3 - 12:00 pm
FFV02	FF Vintage Rubber	FF	Mon Jan 3 - 7:00 am	Mon Jan 3 - 12:00 pm
RCV02	RC Classical Precision	RC3	Mon Jan 3 - 9:00 am	Mon Jan 3 - 5:00 pm
RCV16	RC Vintage Precision	RC3	Mon Jan 3 - 9:00 am	Mon Jan 3 - 5:00 pm
RCV03	RC Vintage IC Duration	RC3	Mon Jan 3 - 9:00 am	Mon Jan 3 - 5:00 pm
RCV14	RC Classical IC Duration	RC3	Mon Jan 3 - 9:00 am	Mon Jan 3 - 5:00 pm
RCV06	RC Vintage 1/2 A Texaco	RC3	Tue Jan 4 - 9:00 am	Tue Jan 4 - 5:00 pm
RCV04	RC Classical E Texaco	RC3	Tue Jan 4 - 9:00 am	Tue Jan 4 - 5:00 pm
RCV05	RC Classical 1/2 E Texaco	RC3	Tue Jan 4 - 9:00 am	Tue Jan 4 - 5:00 pm
RCV07	RC Vintage E Duration	RC3	Tue Jan 4 - 9:00 am	Tue Jan 4 - 5:00 pm
RCV11	RC Sport Cabin E Texaco	RC3	Wed Jan 5 - 9:00 am	Wed Jan 5 - 5:00 pm
RCV15	RC Classical E Duration	RC3	Wed Jan 5 - 9:00 am	Wed Jan 5 - 5:00 pm
RCV13	RC Vintage E Texaco	RC3	Wed Jan 5 - 9:00 am	Wed Jan 5 - 5:00 pm
RCV01	RC Vintage A Texaco	RC3	Wed Jan 5 - 9:00 am	Wed Jan 5 - 5:00 pm
FFV03	FF Vintage Precision	FF	Thu Jan 6 - 7:00 am	Thu Jan 6 - 12:00 pm
FFV07	FF Classic Combined	FF	Thu Jan 6 - 7:00 am	Thu Jan 6 - 12:00 pm
RCV12	RC Vintage Open Texaco	RC3	Thu Jan 6 - 9:00 am	Thu Jan 6 - 5:00 pm
RCV08	RC Vintage 1/2 E Texaco	RC3	Thu Jan 6 - 9:00 am	Thu Jan 6 - 5:00 pm
RCV09	RC Vintage E Rubber Texaco	RC3	Thu Jan 6 - 9:00 am	Thu Jan 6 - 5:00 pm
	Vintage Rain Date	RC3	Fri Jan 7 - 9:00 am	Fri Jan 7 - 12:00 pm
	SIG AGM Vintage AGM & Prizegiving	VCC	Fri Jan 7 - 2:30 pm	Fri Jan 7 - 3:30 pm

Vintage AGM Mon 3rd combined with a BBQ starting at 5:45pm near the Hall at HQ,
Vintage Prize-giving Friday 7th at 2:30pm in the Vintage Car Clubrooms.
Aggregate (Aggy) Not Vintage, but good fun anyway ... starts at 8pm on Mon 3rd.

Frank Ehling International 1/2A Postal Texaco Challenge

Fly in SAM 114's International 1/2A Texaco Postal Challenge

The Old Timers, SAM 114 of Western Ohio in the USA, invite all SAM Chapters to compete for the Frank Ehling International 1/2A Postal Texaco Challenge for 2021. This model airplane event has been flown annually since 1985.

New this year, your team can pick any day for flying during the ninety day window, Sept. 1st through Nov. 30th. This should allow a greater freedom in selecting good weather conditions for each global location in which the contests are held. Once you start flying do not change to another day. If a team member is unable to participate at the team site he may fly at his location on the same day and report results to you.

The results should be recorded as follows: Members name, Model, wing area, weight, and times of Flt 1, Flt 2, Flt 3 and total. Please list the results for all team members. The sum of the times of the three highest scoring fliers will be the team score.

Team managers are asked to comment on the weather and flight conditions, the date and location flown. Please include your SAM Chapter number, address, telephone number and e-mail address. The results are due by Dec 5, 2018. Send to Dennis Sedlock dsedlock5657@att.net

Note: SAM 2015 1/2A Texaco rules apply (15 min. max, best two of three flights, 8 inch max propellor).



***THERE IS STILL TIME TO
ENTER***

Last day - 30th November

The scores of the top three fliers in each team count. Flights can be at different locations, but are made on the same day for the whole team.

Allan plans to organise a South Island team.

This space was reserved for a report on 1/2A flown at Airsail on 18th or 19th September, but covid restrictions meant flying was cancelled. This event may be rescheduled to November 13-14th if restrictions are no longer in place, which will be in time for the entry cut-off date of November 30th.



Tahuna Park at 4am

Turning a cellphone flash on in the dark was beyond my technical capabilities, so a workroom shot of the new *Cloud Tramp* (and a poem) will have to do.

Large LEDs have been replaced by a lighter set and the audio beacon was also removed. Both were bad decisions as the smaller LEDs were barely visible in flight and I had to stay close under the model.

On the morning of the 7th there was a timely break in the rain and wind between 3am and 6am so flights were made under a clear sky in calm conditions.



THE THINGS WE DO FOR C.H.G.

*MIMLOCT moment comes to pass
When frost is crisp upon the grass
For timing here in our En-Zed
Is when the sane are warm in bed*

*Yes, I know they've changed the rules
But there are some, perhaps we're fools
Who choose to play the harder part
And gladly suffer for their art*

*Spurn the early morning start ?
That's what sets MIMLOCT apart !
Sadly, up in Auckland town
They all prefer their eiderdown*

*On appointed winter's morn
Cold and bleak, but ne'er forlorn
I cross the empty local park
And meld into the icy dark*

*A bright headlight upon my hat
Helps with winding, and all that
Then, by chasing beacon flashes
It's off on blind retrieval dashes*

*What do neighbours make of this
Surely something is amiss?
The Police at 4am are slow
There's time to fly, retrieve and go*

*So will it be, again next year
Facing another morning drear
To honour the glorious C.H.G.
(However dubious that may be).*

Bernard Scott, 2021

Hello Mr. Editor of AVANZ News.

I am writing this time to keep everyone up to date with how my brothers Ransid and Ranji (and me too) are getting on with our earomodelling but first I must tell you how my cheeks are red !! You will remember my last letter was talking about "lift pickling" well now I am informed by a helpful earomodeller who most happily lives close to us that I made a mistake and should have talked about "lift picking". So difficult when just one extra letter can make my serious and very useful earomodelling information sound like the Egmounts Cook Book. Anyway I am sure you all knew what I meant and that you have taken advantage of my helpful advice. All three of us (but not so much Ranji who would rather take photographs and do line-dance) have decided that "free flight" models are the most fun. We tried radio controlling models but did not have good fortune because they were always crashing. Our helpful earomodelling neighbour kindly said to us about batteries but he was confused because we were building engine models not electric models. But because we like trying new things we did one electric model and I have sent a photograph of it and some others to you taken by Ranji. We ran out of balsa so we did not have the tail yet when Ranji took his photograph. It was exciting to fly, but we still do not understand why electric models are popular because it was very hard not to crash it. Anyway now that we have tried an electric model we now know all about them so back to the engine models. Their sound is good when we run them outside the garage and even the neighbours think so too. They come out to watch us and wave at us but our crashing has been too much so it is now the free flighting models only for us. Our helpful earomodelling neighbour said we should try some rubber models so we tried that because even though he was confused about the batteries he does know some things about models but maybe he was confused again because the rubber models were too bendy and so now we are doing the engine free flight models with stiff balsa wood which have even better sound.

Ransid bought an old engine called The Olson with a spark plug like a motor-mower and now he gets the most attention from the neighbours. He noticed that some of the neighbours that are at work during the day are missing listening to The Olson so now he only starts it when they have got home but before Coronation Street in case they want to watch. But back to the lift pickling (HaHa !! I know this one now...lift PICKING!!). Our helpful earomodelling neighbour told us about "thermals" and at first we thought he was telling us about his religion because he said the thermals are invisible but still there and sometimes you can feel them on the hairs on the back of your legs and even though they have different names they are still just the One and they bless and curse everyone even if they do not believe in them and if you do not obey the laws of the thermal you are punished with crashes or bad flights or the thermal even takes your model up into heaven and it will never be seen again. We have made notes and will be going to the flying field next weekend to see if we can find some of his thermals so we can believe in them (even though we don't have to to get their blessing). Once we have found the thermals and we really believe in them it will be better for our free flighting because we won't have to waste time looking for them and trying to believe in them every time before flying. Ranji had the idea to capture some in

something but Ransid and I just laughed at him because we knew that we would need a box that was so big that we could not carry it around the field to trap the thermals (as I said, Ranji is more interested in the photographs and the line-dance so he does not understand the thermals as good as Ransid and me). I will be keeping you all up to date with our research into earomodelling but I have to go now because Ransid is starting The Olson and all the neighbours are excited and coming over so they can hear it better.
Randy Crumble

Below: The brothers' electric effort, as mentioned in Randy's letter. Also received were several photographs of other Crumble original builds, both "radio controlling" and free flight. All the Crumble designs display a thankfully inimitable approach that is unmindful of aerodynamic research from the last 150 years.



Battery Allowance Vintage E Rubber Texaco

Wing Area Sq Inch	Wing Loading oz Per Sq Ft	1S Life Battery Size Mah	2S Life Battery Size Mah	3S Life Battery Size Mah	1S Lipo Battery Size Mah Lipo	2S Lipo Battery Size Mah	3S Lipo Battery Size mah
180	10.00	380	190	130	320	160	110
190	9.47	400	200	130	340	170	110
200	9.00	420	210	140	360	180	120
210	8.57	440	220	150	380	190	130
220	8.18	460	230	150	400	200	130
230	7.83	480	240	160	410	210	140
240	7.50	500	250	170	430	220	140
250	7.20	530	260	180	450	230	150
260	6.92	550	270	180	470	230	160
270	6.67	570	280	190	490	240	160
280	6.43	590	290	200	500	250	170
290	6.21	610	300	200	520	260	170
300	6.00	630	320	210	540	270	180
310	5.81	650	330	220	560	280	190
320	5.63	670	340	220	580	290	190
330	5.45	690	350	230	590	300	200
340	5.29	710	360	240	610	310	200
350	5.14	740	370	250	630	320	210
360	5.00	760	380	250	650	320	220
370	4.86	780	390	260	670	330	220
380	4.74	800	400	270	680	340	230
390	4.62	820	410	270	700	350	230
400	4.50	840	420	280	720	360	240
410	4.39	860	430	290	740	370	250
420	4.29	880	440	290	760	380	250
430	4.19	900	450	300	770	390	260
440	4.09	920	460	310	790	400	260
450	4.00	950	470	320	810	410	270
460	3.91	970	480	320	830	410	280

470	3.83	990	490	330	850	420	280
480	3.75	1010	500	340	860	430	290
490	3.67	1030	510	340	880	440	290
500	3.60	1050	530	350	900	450	300
510	3.53	1070	540	360	920	460	310
520	3.46	1090	550	360	940	470	310
530	3.40	1110	560	370	950	480	320
540	3.33	1130	570	380	970	490	320
550	3.27	1160	580	390	990	500	330
560	3.21	1180	590	390	1010	500	340
570	3.16	1200	600	400	1030	510	340
580	3.10	1220	610	410	1040	520	350
590	3.05	1240	620	410	1060	530	350
600	3.00	1260	630	420	1080	540	360
610	2.95	1280	640	430	1100	550	370
620	2.90	1300	650	430	1120	560	370
630	2.86	1320	660	440	1130	570	380
640	2.81	1340	670	450	1150	580	380
650	2.77	1370	680	460	1170	590	390
660	2.73	1390	690	460	1190	590	400
670	2.69	1410	700	470	1210	600	400
680	2.65	1430	710	480	1220	610	410
690	2.61	1450	720	480	1240	620	410
700	2.57	1470	740	490	1260	630	420
710	2.54	1490	750	500	1280	640	430
720	2.50	1510	760	500	1300	650	430
730	2.47	1530	770	510	1310	660	440
750	2.40	1580	790	530	1350	680	450
760	2.37	1600	800	530	1370	680	460
770	2.34	1620	810	540	1390	690	460
780	2.31	1640	820	550	1400	700	470
790	2.28	1660	830	550	1420	710	470
800	2.25	1680	840	560	1440	720	480

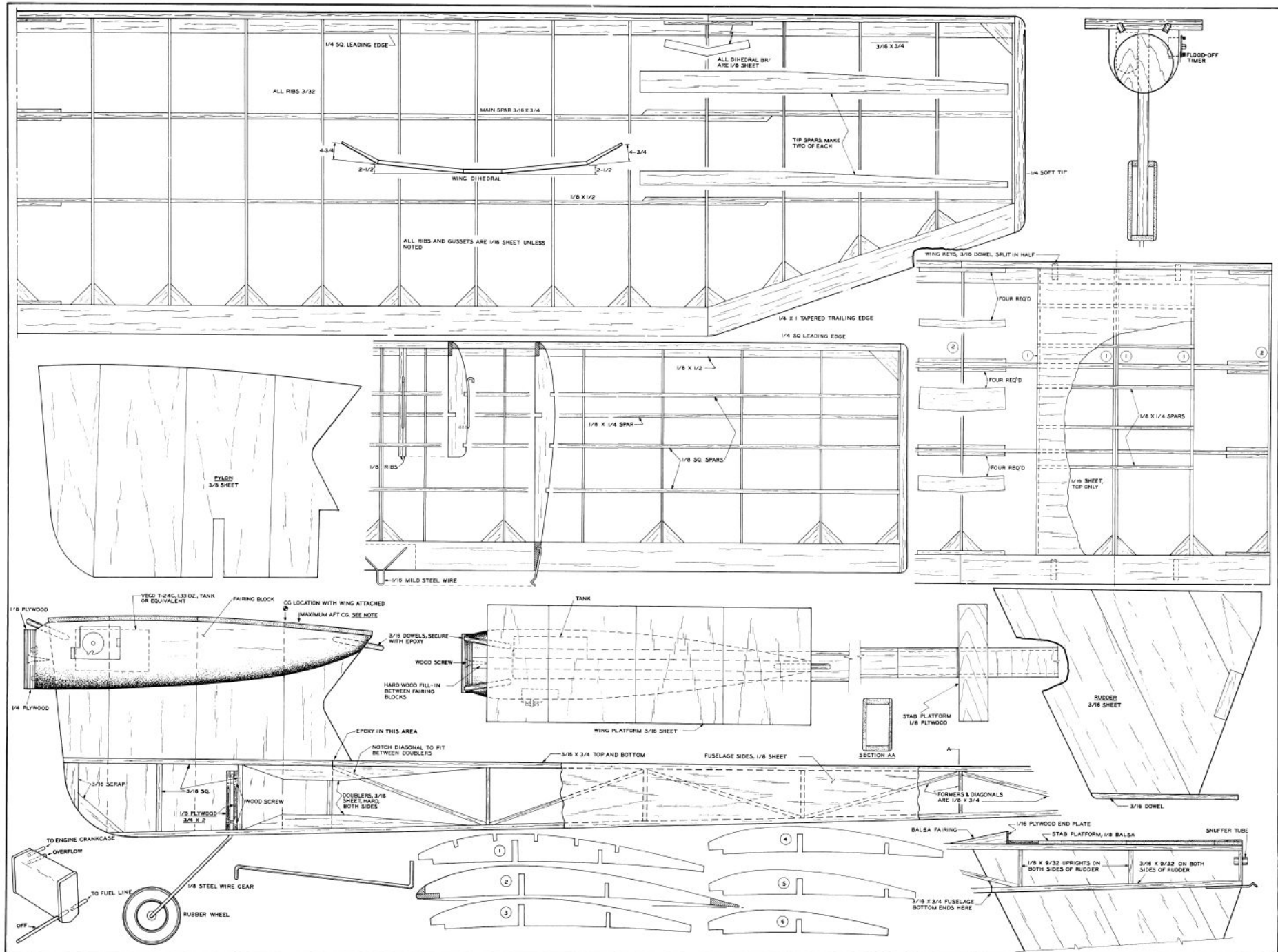

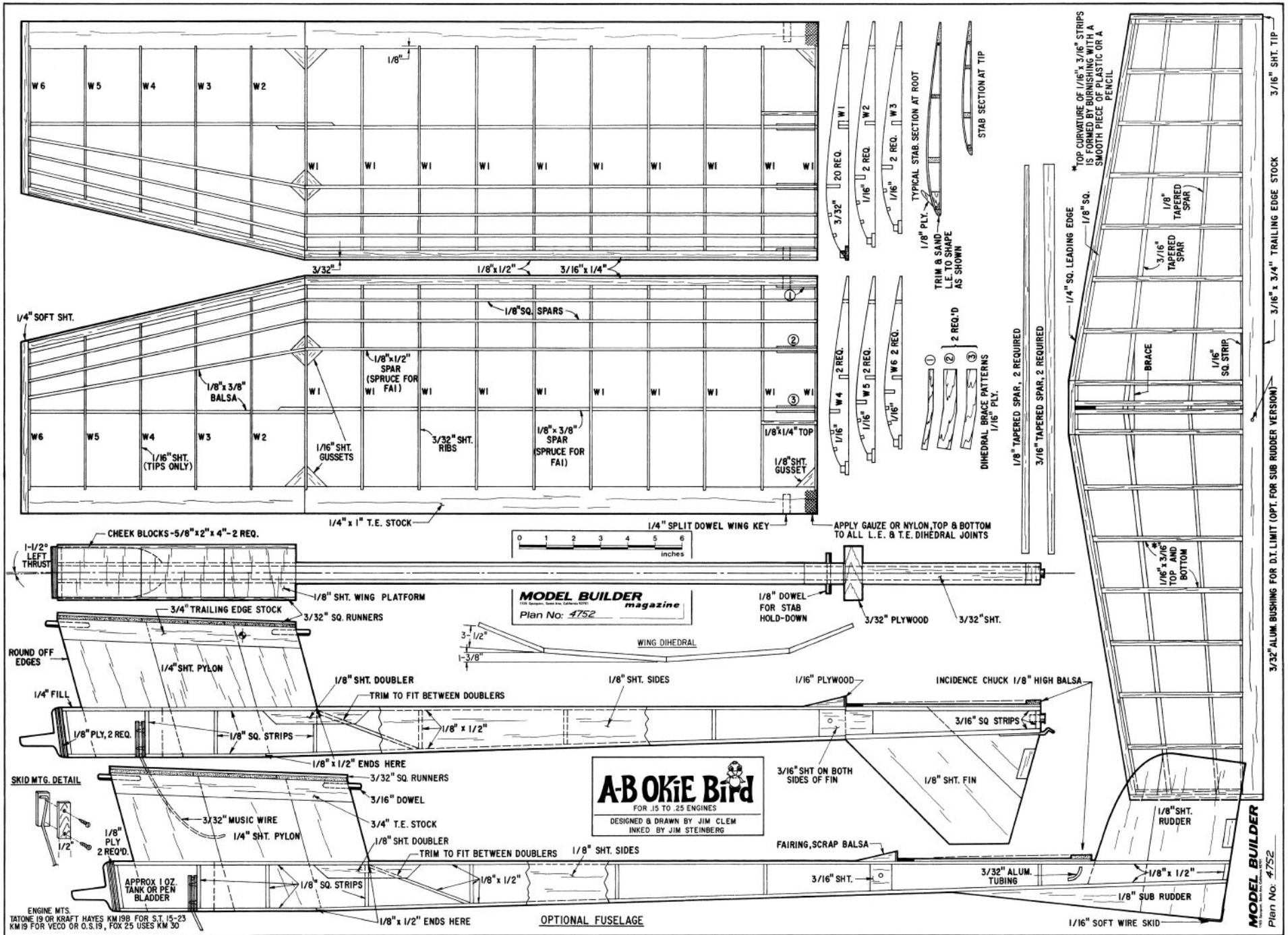

Almost, but not quite.

The *Witchawk* was one of Clem's best-known designs and *Fire Wagon* bears a close resemblance to this Nationals-winner.

Unfortunately, the *Witchawk*, like Clem's similarly well-known *Country Boy*, falls outside our FF Classic and RC Classical eras.

Jim Clem was noted for easily built and trimmed designs that had high performance.

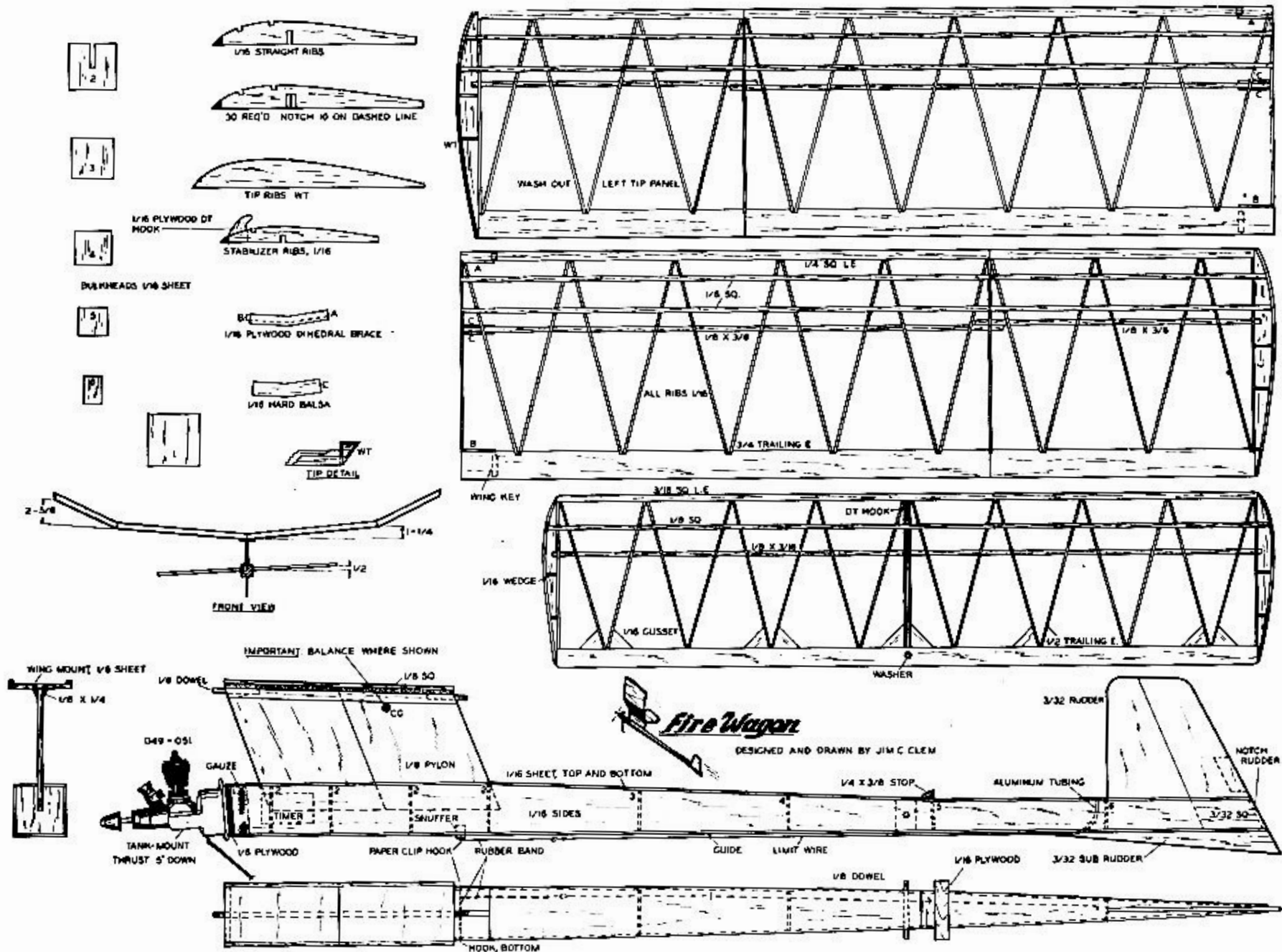

In this issue

*From the Editor
Contacts
More on Spark
Ignition
Transistor Ignition
Radio and Spark
Ignition
CPMAA Vintage
RC Champs.
Diesel Fuel
A Texaco trials
More on the Scram
Heron Gas Buggy
On FF and CL
Gareth Newton
Meet notice.
Events Calendar
Top Ten Board
Italian Tomboy
Rally
AVANZ Plans
Vintage SIG News
AGM Notice
Classical Poll
Result
Texaco Poll
Withdrawn*

Editor Graham Main wrote of his progress on getting to grips with a Forster 29 and an Ohlson 23. The piece is well worth study if you are thinking of trying a sparkie. The set-up of transistor ignition is also covered, as is the result of tests for radio interference.

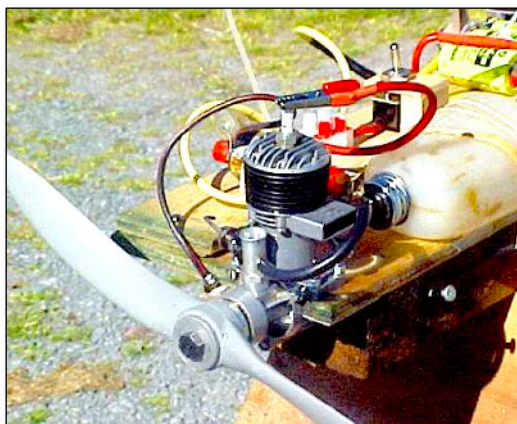

Neil McDougal reports on his A-Texaco experiments with a Vampire, and PAW 1.5 using 11 and 12 inch props. Six minutes motor run suggested bit more experimentation was required.

The Leader Board was starting to gain momentum with 24 scores recorded. It appears that the top 10 scores in each event were listed, whoever scored them, as several fliers had more than one score

recorded in an event.

The AVANZ Plans Library was steaming ahead with 400 plans on the website, but with a total of 10,000 plans, there was still a long way to go. With Outerzone being the easiest go-to site for plans, it is easy to overlook the AVANZ Plans Library. We owe continued appreciation to Mark Venter and others who have digitised these plans for our use.



Allan Knox reported on his 79", 10 oz/sq.ft Scram. The OS.40 cross-flow turned a 10x6 ASP at 13,500 for a sprightly climb.

The 63rd Nationals at Carterton got its first advertising. Debuting at the National were RC Vintage E-Duration, E-Texaco and 1/2E-Texaco, plus one new FF event, Nostalgia1/2A Miniature Replica.

More on Tomboy rallies, and another photograph of that delightful ROW Tomboy.



The CPMAA Vintage RC Champs on 17-18 September were reported. A strong breeze took two models beyond control, each shedding half a wing. *Red Zephyrs* took first and second in Vintage Duration and first in Precision. Bryan Treloar's Duration winning version had spark ignition.



FÉDÉRATION AÉRONAUTIQUE INTERNATIONALE

Diplôme de Record

NOUS SOUSSIGNÉS CERTIFIONS QUE

F. D. BETHWAITE (Nouvelle Zélande)

A ÉTABLI LE RECORD SUIVANT POUR MODÈLES RÉDUITS D'AÉRODYNES :

Record du Monde & Record International de DUREE : 7 h. 37 mn

N° 24 Planeur Télécommandé

Long Bay Auckland

LE 2 avril 1956

POUR

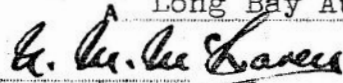

LE PRÉSIDENT,

LE DIRECTEUR GÉNÉRAL DE LA F.A.I.

LE PRÉSIDENT DE LA F.A.I.

Prior to the end of the 1933 flying season the SMAE did some serious "fiddling with the Wakefield Cup Rules. First they deleted the "Any Type of Power Rule", restricting power to "Rubber Power Only", then they restricted the wing area to be between "190 & 200 sq. inches", then they placed a limit on total weight including rubber motors to be "4 Ounces Minimum", and "finally they made the flight time to be the "Average of Three Flights". So much for the threat of petrol powered, and outdoor-indoor aeromodels!

The 1934 Wakefield Cup Contest was scheduled for Sunday, June 24, and from America came boxed aeromodels from Team USA to be flown by the Proxy Team Members at the contest. The USA Team Members were Gordon S Light, of NY University, the "Unofficial 1932 Wakefield Cup Champion", who came in third in 1933, Walter Getsla of Chicago, Illinois, the stalwart of the Illinois Model Airplane Club. Walter sent a cleanly designed mid-winged gear driven Wakefield. Getsla's

Wakefield was featured in the 1934 re-enactment in SAM 35 Year Book No. 3 "And So To Warwick". Alwyn Greenhalgh and Mike Hetherington made copies of Walter's Wakefield, and Getsla was there to relive the day. In fact to this day Walter Getsla is remembered by the Oakland Cloud Dusters, to which he served as the Treasurer for many years, and to whom is placed a perpetual Wakefield Trophy, in his memory. The third Team Member was Frank Zaic, of NY, NY, who sent a beautiful.

sheathed streamlined Wakefield; the other members of Team USA were: A Howell; A H Du'on; and L M Adams. "Fetchermite" Horace Claymore, engaged to retrieve "Grasshopper" for J B Allman could hardly wait for that day, in fact I paraphrased him: "At last, the day of the 1934 Wakefield Contest arrived! Allman asked me to be at Warwick Common by 9:00am. There was no

wind, but a fine drizzle persisted all day, sometimes heavier, sometimes a little lighter, but always there. The Tote Building was the only cover that most of us had between lights. During the eliminators, the "Grasshopper" broke its port wing right across about half way along, and consternation abounded. Allman set about repairing. I remember speaking to him about the weather. Allman replied "The weather, Horace, is perfect for us..." "Grasshopper"(had a geared) three minute power run!

Yet... FIRST FLIGHT: 8.5 seconds. SECOND FLIGHT: Slight stall 163 seconds. THIRD FLIGHT: Allman became a little tense. The moment of drama I mentioned earlier was now approaching. Allman told me "I am putting on absolute maximum turns, the rubber can break!" As I held the model, and Allman piled on the turns, I became aware that the whole world was watching us, we were at the take off board and Allman placed "Grasshopper" on the board and then picked it up and moved the wing forward! He then placed the model back on the board and looked at the starters. I could not believe what I was seeing! "DON'T LET GO", I called to Allman. He paused, picked the model up and turned to me not saying a word. "YOU MOVED THE WING FORWARD" I said. "BUT THE MODEL WAS STALLING. You should have moved it (the wing) back." Allman slid it back again then he replaced the "Grasshopper" on the board, looked at the timekeepers, and she was off! "Grasshopper" set to fly in very large circles of about 250 to 300 yards diameter, cruised up to 70 feet and recorded 164 seconds. The Cup was ours!"

Frank Zaic was third this time, Walter Getsla was tenth, and Gordon S Light's Wakefield was crashed on the field. In all fairness, the Proxy Team has the most difficult of tasks, and the shortest amount of time to practice with their charges. If they can win even a tenth place they are doing quite well under difficult circumstances.

J B Allman's original "Grasshopper" 1934 Wakefield Cup winning model.

Pictures were taken in 2021. The model was sent from Allman in South Africa to Alwyn Greenhalgh for restoration many years ago. I am told that it appeared to have been deliberately tampered with during transit and this explained the very poor state of repair when it reached 'The Commander' in England. Apart from some very minor damage to the covering - since repaired - and the absence of the rear motor peg the model is ready for flight.

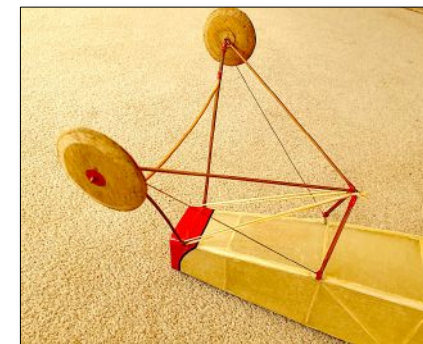
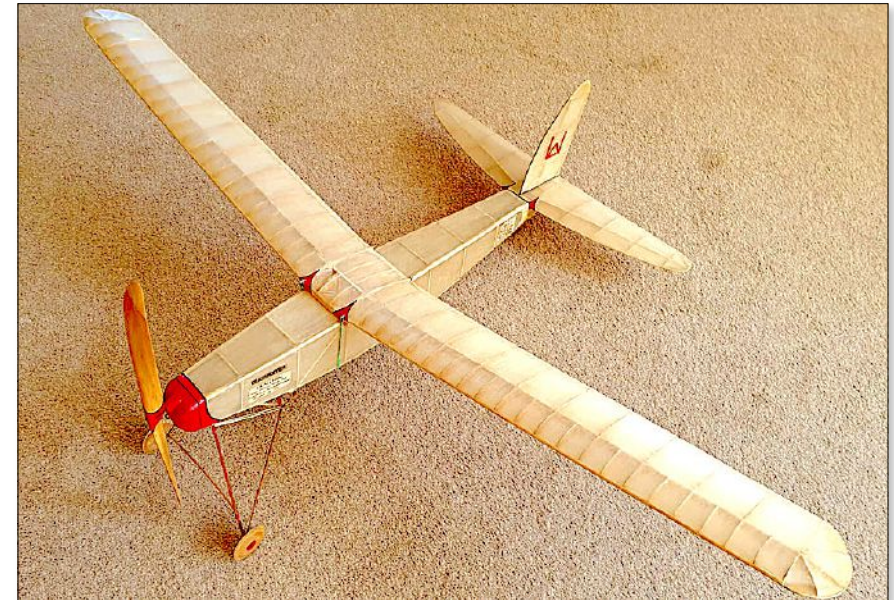

Undercarriage and nose with gearbox for multiple motors

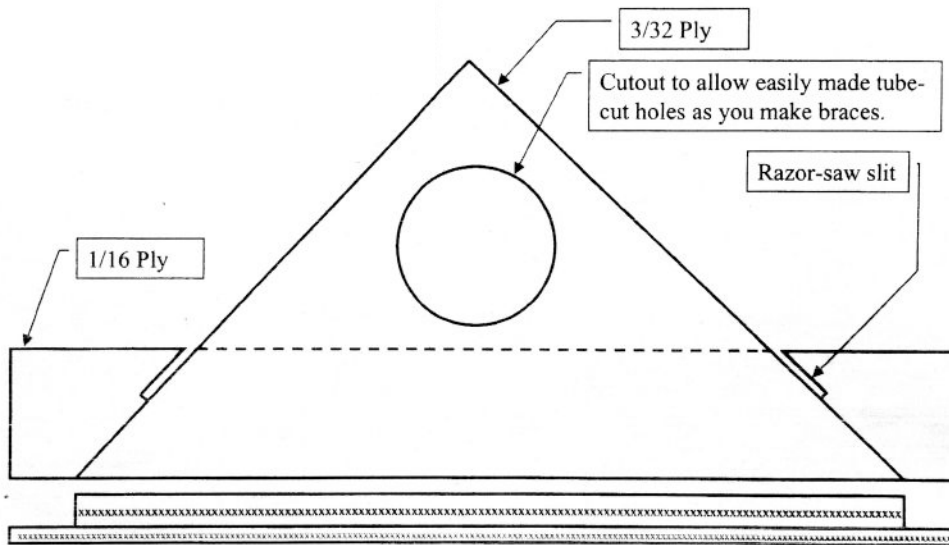

RIGHT ANGLE

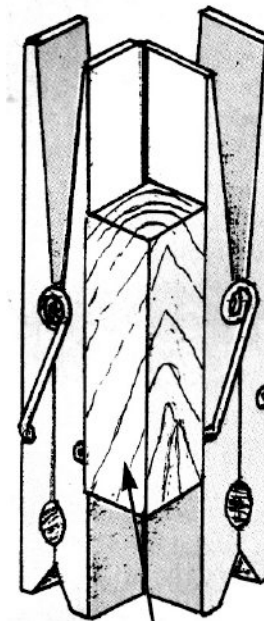

STRAIGHT

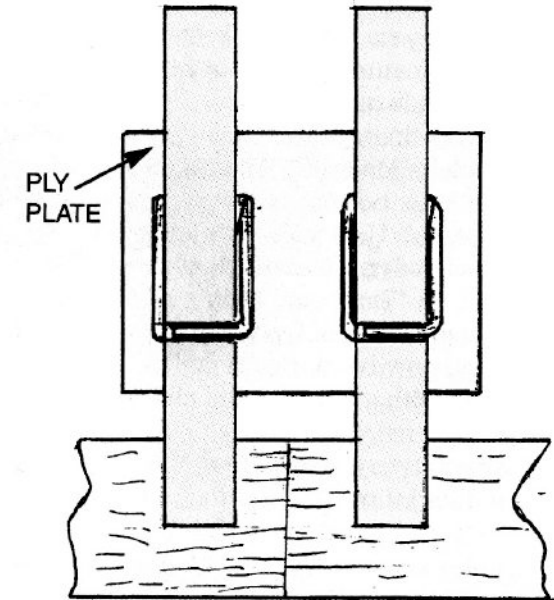

BLOCK OF HARDWOOD

From #185:

Fliwise Box 90amaru NZ



The Fliwise 'Zap' towline winch and line. Designed and made especially for towing Thermal Soarers. Legal FAI line pennant and ring. Basic winch \$23, winch complete with line etc \$27, overseas postage extra.

Ad from the 1960's. Anyone remember this trader?

Chris Murphy was able to answer the question: "Fliwise Products was run by Phil Corfield who produced a whole range of modelling accessories in his heyday. Mainly oriented towards CL fliers but a few other items as your pic shows. He's still around, living in Dunedin and still flying a bit of FF and CL and (unless my eyes deceive me) going by the FFONZ facebook page he was at last weekend's South Island Champs..." In a moment of synchronicity on the same day that Chris's email arrived, the editor found a reference to Fliwise products in a 1999 AMI magazine. It asked for the design date of the Fliwise *Paper Chaser* control line kit.

?





"This model will appeal to connoisseurs of the vintage scene and is representative of French practice of the late forties. It should present no problems to any builder with a modicum of experience, although some aspects of the construction differ from British and U.S. methods of that time. Rene has kept copious notes of his models over the years. Le Vibrant was built in the Autumn of 1947 to replace a model lost during the French Champs (D/Ts had hardly arrived). In the following year it won two major contests and made second in the Champs. A curious rule change frustrated Rene's hopes as on the basis of sheer performance it would have won! Later it placed 5th at the Eaton Bray International, a prestigious event in those days. Unfortunately it met its doom in the appalling weather. Don't believe all that stuff about halcyon summer days of past times! If you decide to build one, you will have something that little bit different, which flies well. You will not be disappointed."

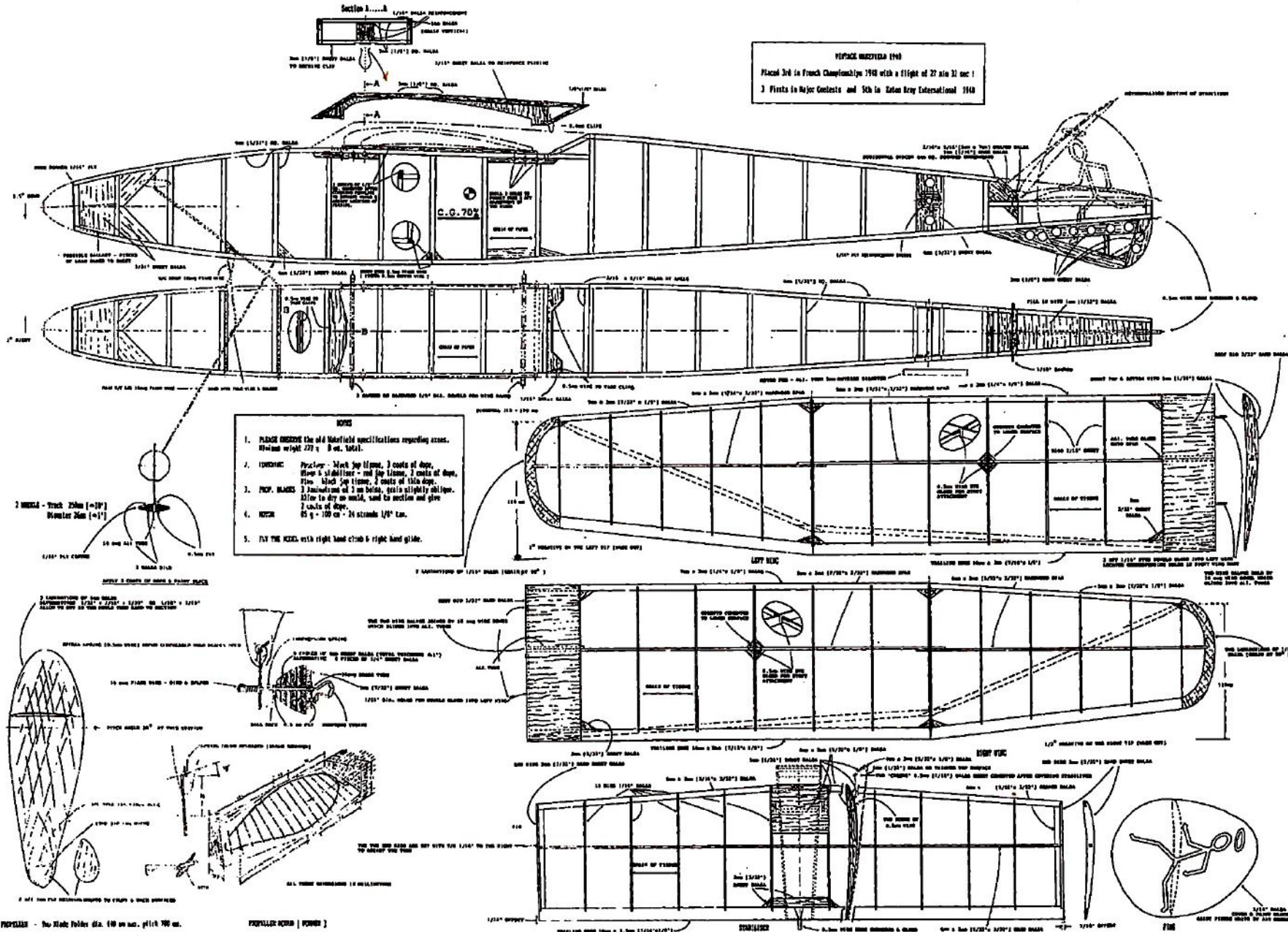



Papier Mache Models Fred Mayfield

Usually papier-mache work is made by soaking paper in water until it becomes pulpy and then making a mixture from this pulp and a small amount of plaster of Paris. This mixture is plastic enough to be worked with the hands or molded from patterns into any desired shape. When the water evaporates, the result is a light and fairly strong form. For model work the procedure used is slightly different in that the paper is not reduced to a pulp but used in sheet form.

The first step in preparing the parts of a papier mache model is to carve or form a pattern of the part to be

constructed. This form can be made of white pine or balsa. The flat wing mounting of a fuselage can be carved to shape or built up with clay. Any other protuberances (such as headrests, wing fillets, etc) can also be built up of clay. The pine form should then be sanded smooth and varnished. If balsa is used, several coats of shellac should be applied. The form should also be rigged up so that it can be rotated.

Cut a sheet of bamboo paper into strips approximately 2"x 8". Cut up only one sheet at a time until you know just about how many you will need. Grease the form

well with Vaseline, cold cream, or some other greasy substance. Be sure to apply it liberally so that the paper will not stick to the form.

Next, mix a bowl of wallpaper paste. Now drag one of the paper stripes through the paste. Wipe off the excess. Apply this coated paper strip to the form in a spiral direction by rotating the form. Repeat this process with other strips until the form is completely covered with one coat of paper. Be sure to have a slight overlap at the junction of the strips.

Another layer of paper is applied in the same manner, except that the spiral should run in the opposite direction. We need still another layer to obtain a safe margin of strength. This third coating is applied in the same direction as the first. For normal work, three coats will suffice. Use more layers if greater strength is desired. Let the completed job dry for about 24 hours to allow the paste to set and dry.

To remove the fuselage from the form, cut the fuselage along the bottom, front and back, and slide it off the form. If it sticks, or if the shape does not allow the removal to be made in this fashion, cut it full length. If it sticks too hard to the form it may be necessary to cut it along the top as well. I found that two bulkheads situated directly beneath the wing mounts are the only necessary internal supports. These should be made first of cardboard and fitted in and then cut out of laminated 1/16" sheet. After the bulkheads have been glued in place, the seam should be glued and sealed with a 1/2" strip of bamboo paper.

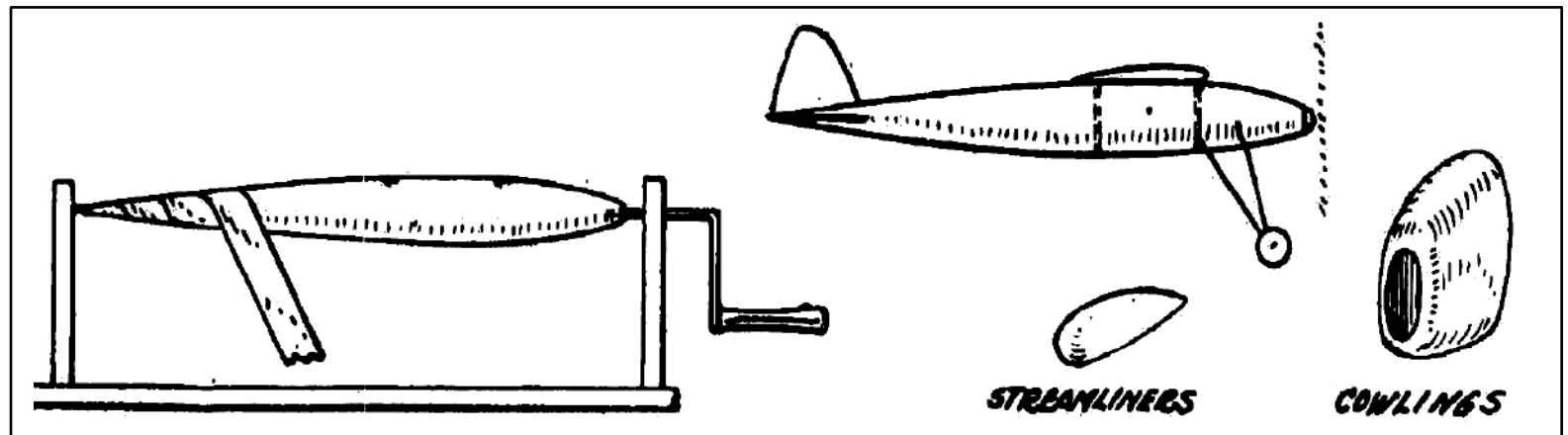

Far removed from the functionality of current Wakefields, this elegant Canadian design would today be well suited to a Concours event.

A winning time of 1m 12s indicates the state of Wakefield flying in 1935.

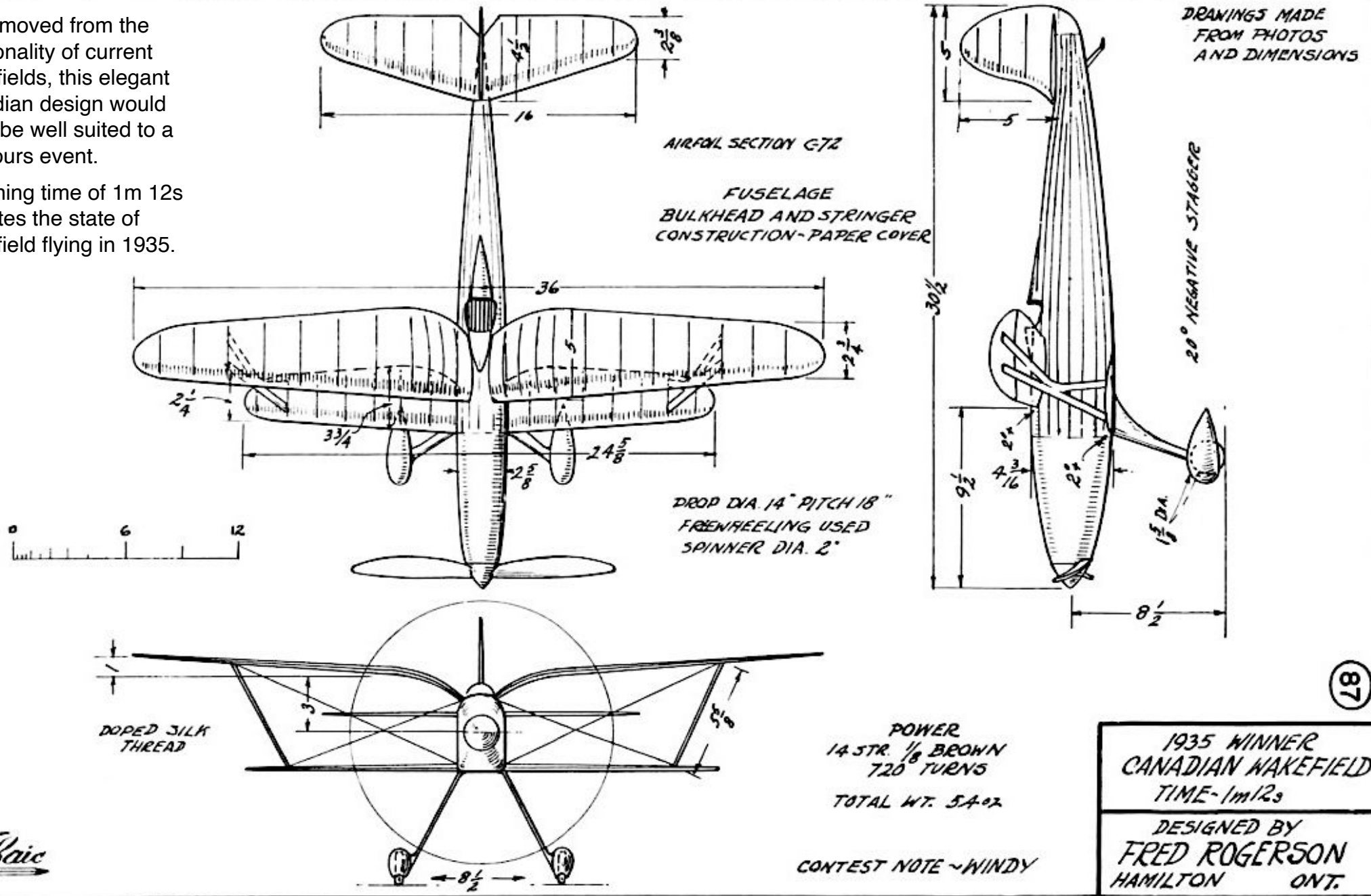

Ehling's *Flying Stick* may have been the "inspiration", if that word is not too misleading, for the better known *Flying Aces Stick* (below) that was published in the September 1936 issue of *Flying Aces*. Or perhaps it was the other way around?



Rebelling against common sense and good taste, the Hamilton MAC has scheduled a competition, aerobatic no less, for the *Flying Aces Stick*.



Hamilton MAC Aerobatics - Flying Aces Stick

Club Day on 17 October will include an aerobatics contest for Flying Aces Sticks. This will be very low key and aimed at having a lot of fun. It should be hilarious for spectators as the contestants try achieve recognisable manoeuvres with models that are definitely not intended for aerobatics.

This event will probably be a world's first but it is unlikely that the rest of the world will care.

Rules

1. Model is a Flying Aces Stick that conforms (loosely) to the HMAAC plans.
2. The sequence of manoeuvres listed in the Schedule is flown (attempted?) once or twice optionally with both in one flight, or in two separate flights. The best score will count.

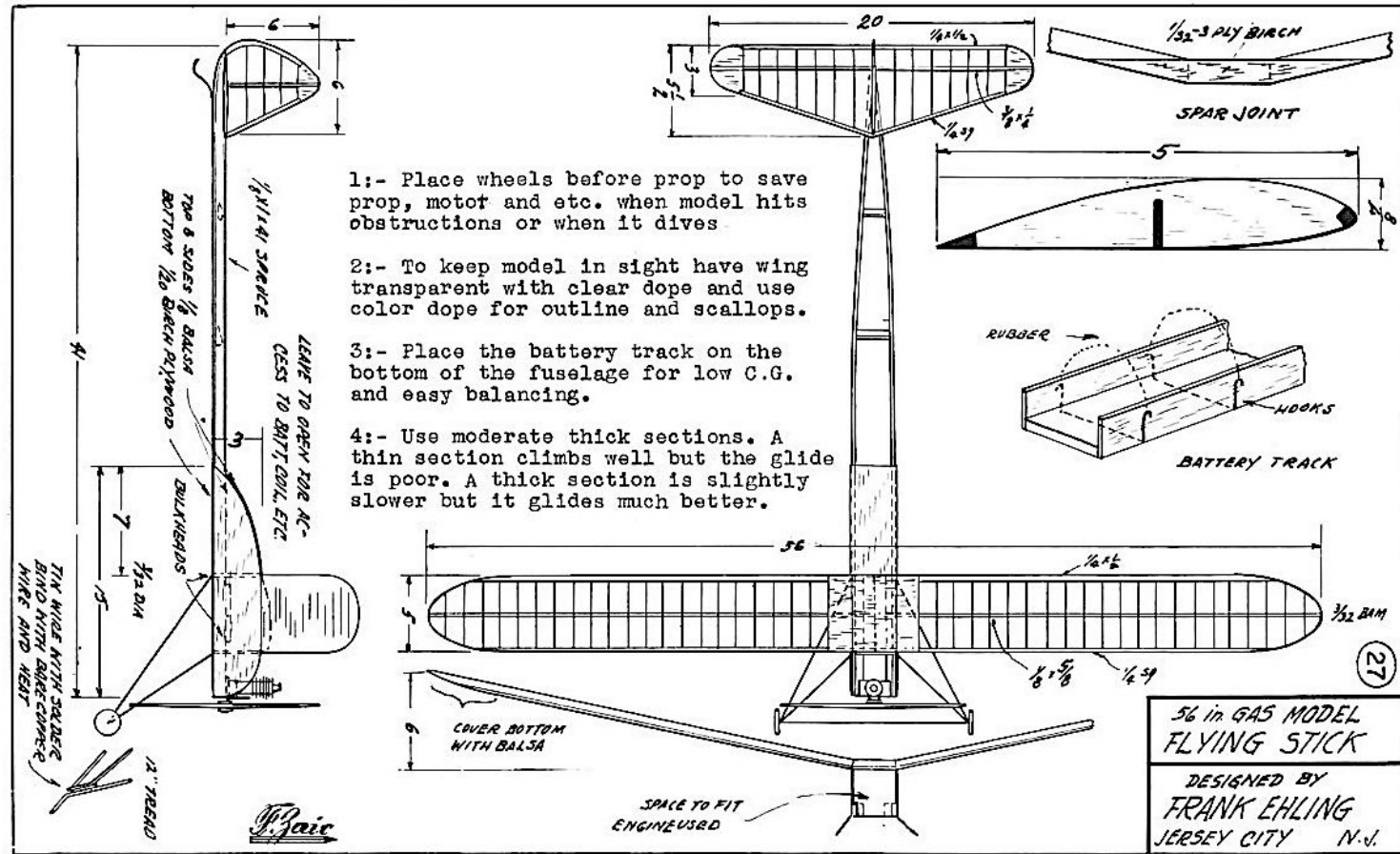

3. All manoeuvres are flown parallel to the strip and are centred. (This is the intention but Flying Aces Sticks do not always cooperate.)
4. All manoeuvres are scored out of 10 with no K factors. (As a kindness, manoeuvres that deserve less than zero are ignored.)

Schedule

- Two loops
- One roll (as axial as possible)
- Stall turn
- Immelmann (half loop up and half roll)
- Reversal (half roll and half loop down)
- Inverted flight minimum 3 seconds
- Touch and go



Always popular and a successful design in NZ contests. Comment from the Zaic Yearbook:

"I believe that Joe Hervat's outdoor glider is about the finest design that I have seen. I have built one and can get about 150 feet of altitude and over on windy days. It can ride the wind well and has a beautiful glide when in good shape,

The general outline of Joe Hervat's glider is as shown on the sketch. It is the Editor's belief that the peculiar fuselage shape has a great deal to do with its good spiral stability. From observing one of these designs, it was noted that recovery from a side slip was very fast and that there was no tendency to go into a spin such as is often found in other gliders. This would seem to indicate that we should pay more attention to our old friend, the Center of Side Area."

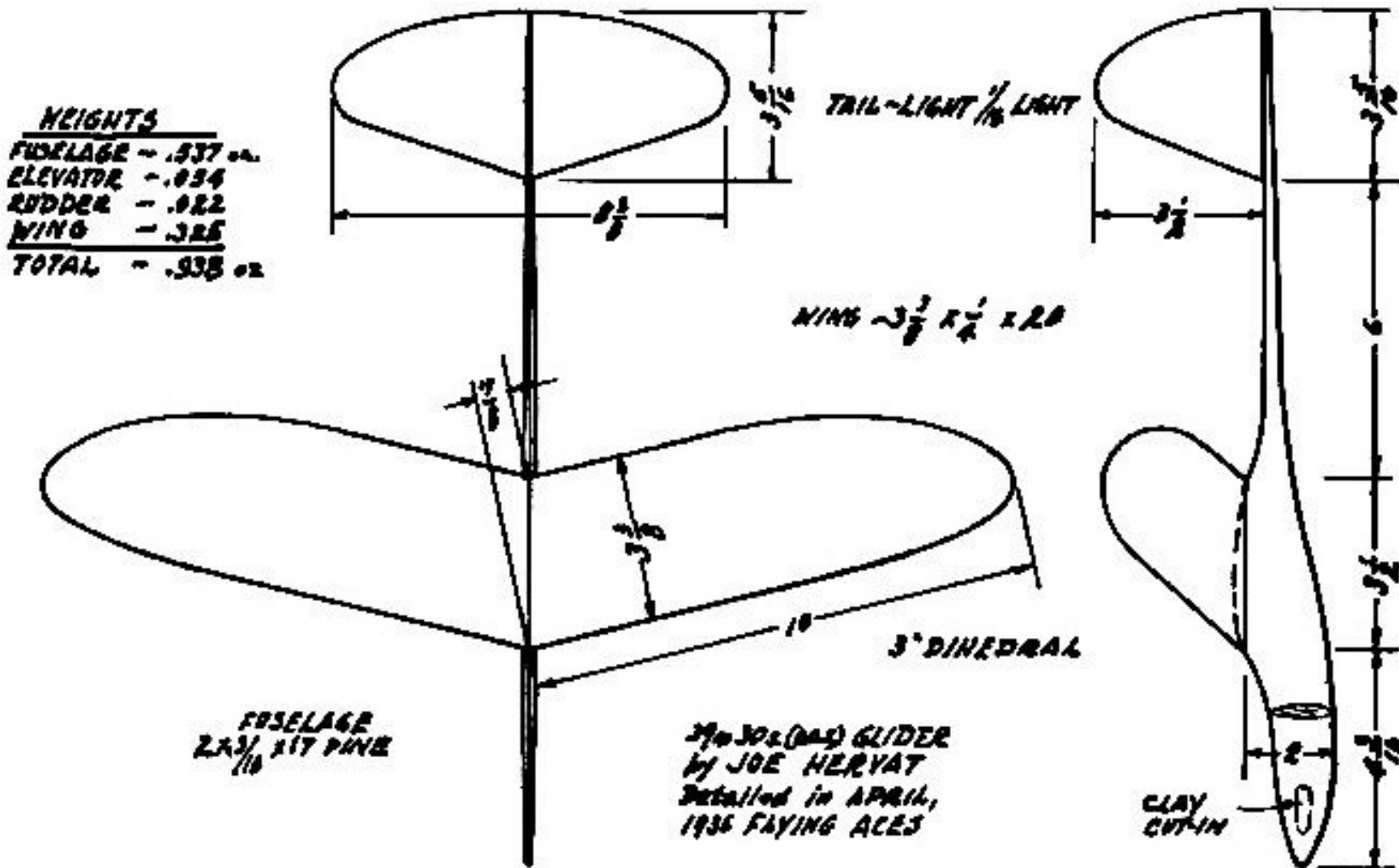

Gerontius Foggin had conceived the notion that warm air caused models to fly for longer and resolved to test this by waiting until he and son Horatius felt warmth on their cheeks before they launched. Their vigil continued long after the club's charabanc had departed, taking all other members of the Aston-Nosbury Aeronautical League back into town for steaming cups of cocoa and lashings of jolly hot buttered scones.





Allan Knox's MG2 for 1/2E-Texaco

I don't know how, but it is exactly on weight with 6 rubber bands for the wing. 13.6 ozs. 330 sq ins. That is 6 oz/ft sq and right on 300MAH 2S min weight. Amazing fluke although it was my target. I nearly always get then over weight. Just finished it, now all I need is some decent weather to try her out. Needless to say, I have enjoyed my lockdown !

(Later) I have now flown the MG2. I snuck out this PM. Cold but no wind and that is the exception at the moment. I see exactly what you mean - it wanders! No surprise there for you *(the Editor's 1/2A- and A- Texaco MG2's both wander at random if left unguided)*. Quite manageable though. Pitch is nice. CG is back at 50% which I calculated would work for me. It is a little more stable in pitch than expected. Glide I wouldn't call fast on this one but it is light at 14.25 ozs. Has good climb too. Stall is soft and straight ahead. The glide seems light and bouncy so I think it will thermal well given half a chance. Just the one flight spent sorting it out but it still did 13 minutes. I think it will work OK.

Allan

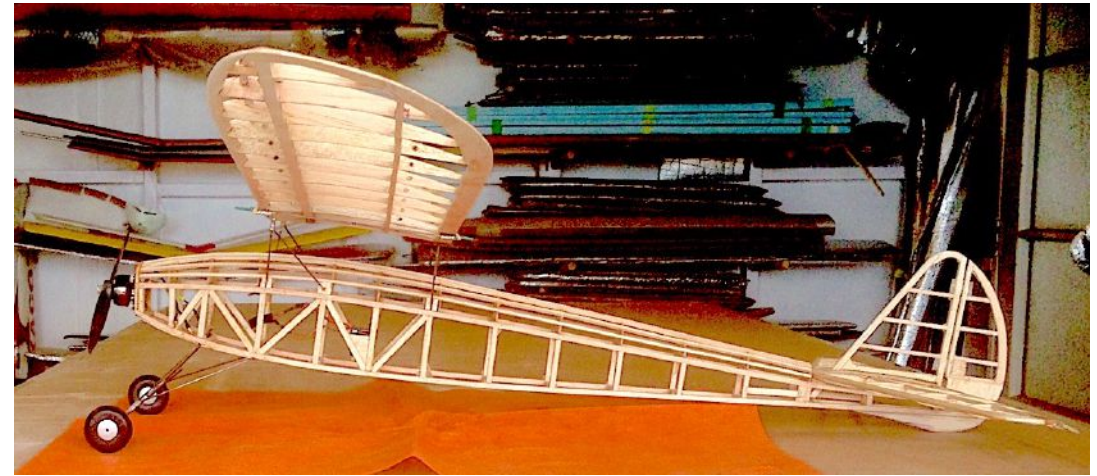



Cavu is finished and was test flown yesterday. Rough CG check. It only needs 45% power for take off and will add mix to counter full throttle looping. On full throttle it climbs well with 1400 & 2200 3s.

Hoping to use it for Duration & Precision. E-Texaco may be possible depending on the ability of a 3s 350mah to get it up there, will use separate Rx battery.

Barry

Cavu (Ceiling And Visibilty Unlimited) was designed by Ken Willard. Its plan first appeared in the April 1938 M.A.N.

Ken Willard will be remembered for his "Sunday Flier" column which ran for over twenty years in *Radio Control Modeler* magazine. His "School" series of designs (*School Boy*, *School Girl*, *School Master*, etc) was popular. Less memorable, perhaps, is that Willard in 1962 flew what was then the world's smallest RC model, and then in 1972 changed tack and flew what was at the time the world's largest RC model.



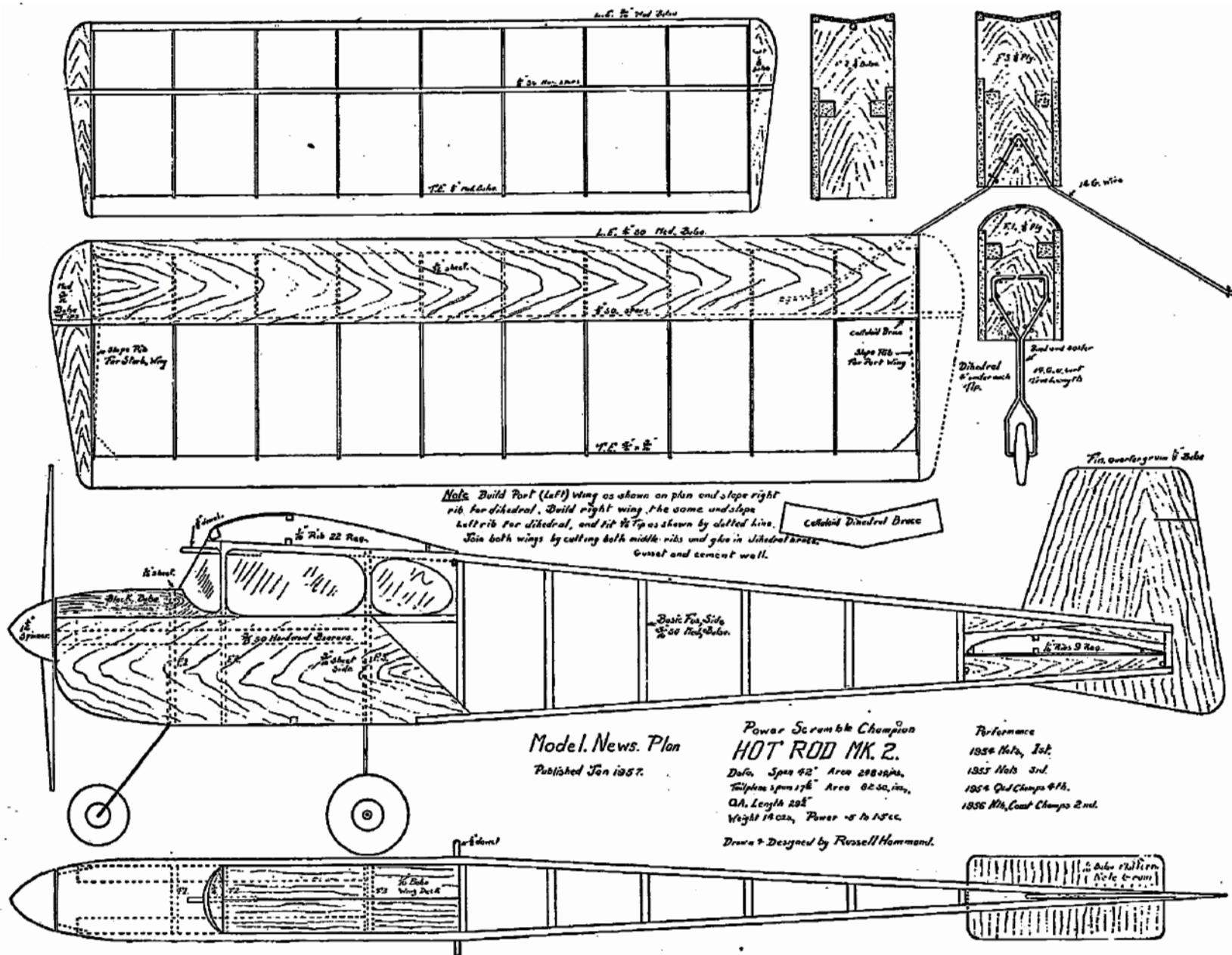

"This job has been one of the most outstanding scramblers in Australia over the past few years.

Winner of Australian, Interstate, and State Championships, the original has up over 600 flights and is still going strong. Just read through the instructions and you'll be reaching for balsa and glue.

My introduction to power scrambling was at the '52 QLD. State champs. For this event I used a modified HELLS BELL, Elfin 1.49 powered. Fifty of us were lined up, and organised for the panic. After an hour of running, flying, running, I came out on top.

The model isn't light and it will take a GRAND-DADDY of a thermal to carry it away - even one that makes the hairs on the back of your legs tingle. No searching for this one. It isn't large - a big model is hard to run with, and easier for other planes to collide with in mid air." RH

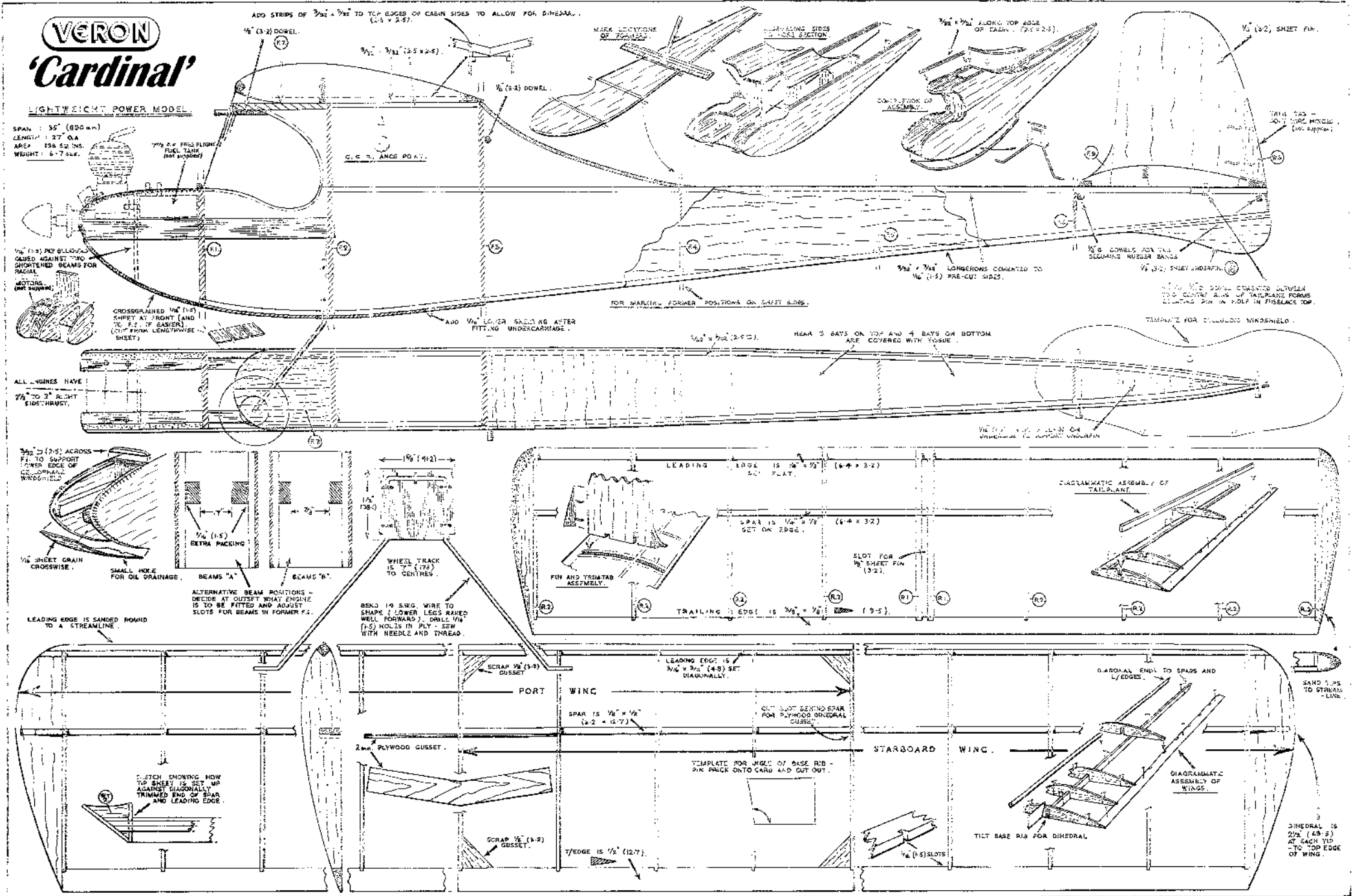

EARLY AEROMODELLING BOOKS

KEIL KRAFT HANDBOOK

PRICE ONE AND SIXPENCE

THIS ISSUE CONTAINS:

- Articles on Petrol Models, Engines, Gliders, Duration Models, Control Line, Solid Gliders, Flying Scale and Solid Scale Models.
- Instructions for Building Solid Scale Stands, Doping and Covering, Trimming and Engine Running.
- Full Size Plans for the Bantam — a 16 Solid Glider.
- 12 Articles, 7 Plans and 36 Drawings & Photographs.
- Complete List of all Keil Kraft Kit & Model Supplies.

1947

A YEARLY REVIEW OF THE LATEST DEVELOPMENTS OF AEROMODELLING

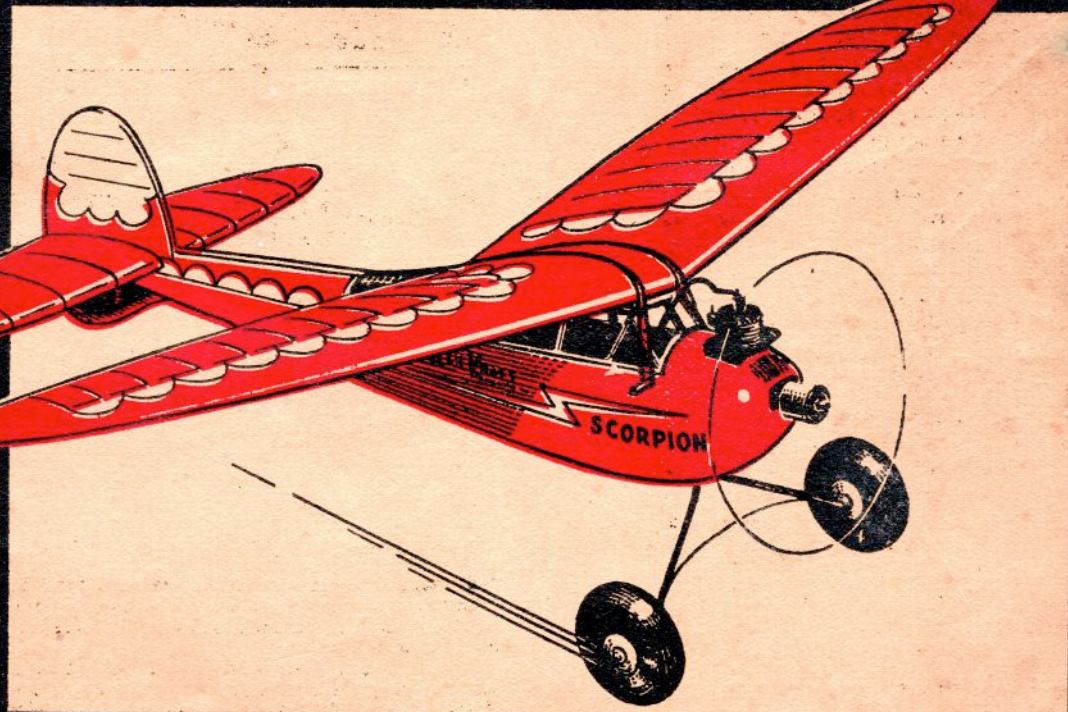

Complete Price List of KEIL KRAFT KITS

PETROL MODELS.		GLIDERS.	
HORNET 28" span Wood wheels 1...	£ 2 6	G-1 VICTORY 30" span 1...	£ 4 0
SCORPION 44" span Wood wheels 2...	2 7 6	G-2 INVADER 40" span 3...	6 6
" " 2 1/2 Air wheels 2...	2 17 6	G-3 MINIMO 50" span 5...	7 0
JUNIOR 60 60" span Wood wheels 3...	2 19 6	G-4 SOARER BABY 36" span 2...	5 0
" " 3 1/2 Air wheels 3...	3 17 6	G-5 " MINOR 48" span 1...	8 0
FALCON 96" span " " " 4...	Price later	G-6 " MAJOR 60" span 1...	11 6
DIESEL MODELS.		SOLID GLIDERS.	
ROVER 40" span " " " 1...	19 6	SG-1 POLARIS 20" span 1...	2 6
		SG-2 VEGA 12" span 1...	1 3
		SG-3 SPOOK 12 1/2" span 2...	1 6
		SG-4 COMET 24" span 1...	3 6
DURATION.		SOLID SCALE.	
ACHILLES 24" span " " " 1...	3 8	SC-15 LIGHTNING " " " 1...	4 0
AJAX 30" span " " " 1...	5 6	SC-10 MOSQUITO " " " 1...	4 0
POLYDI 40" span " " " 1...	14 6	SC-19 M. E. 210 " " " 1...	4 0
ORION 23" span " " " 1...	3 6	SC-17 AVENGER " " " 1...	3 6
STRATO BABY 20" span " " " 1...	5 0	SC-5 BARRACUDA " " " 1...	3 6
COMPETITOR 32" span " " " 1...	6 6	SC-2 METEOR IV. " " " 1...	3 6
CONTESTOR 45 1/2" span " " " 1...	Price later	SC-12 THUNDERBOLT " " " 1...	3 0
EAGLET 24" span " " " 1...	4 6	SC-14 TYPHOON " " " 1...	3 0
FLYING SCALE.		SC-11 HURRICANE " " " 1...	3 0
MUSTANG 24" span " " " 1...	5 6	SC-18 AIRACOBRA " " " 1...	3 0
TYPHOON 26 1/2" span " " " 1...	5 6	SC-6 SPITFIRE " " " 1...	3 0
THUNDERBOLT 27" span " " " 1...	5 6	SC-8 MUSTANG " " " 1...	3 0
SPITFIRE 22" span " " " 1...	5 6	SC-4 TEMPEST " " " 1...	3 0
PIPER CUB 26 1/2" span " " " 1...	5 6		
ZERO 24" span " " " 1...	5 6		

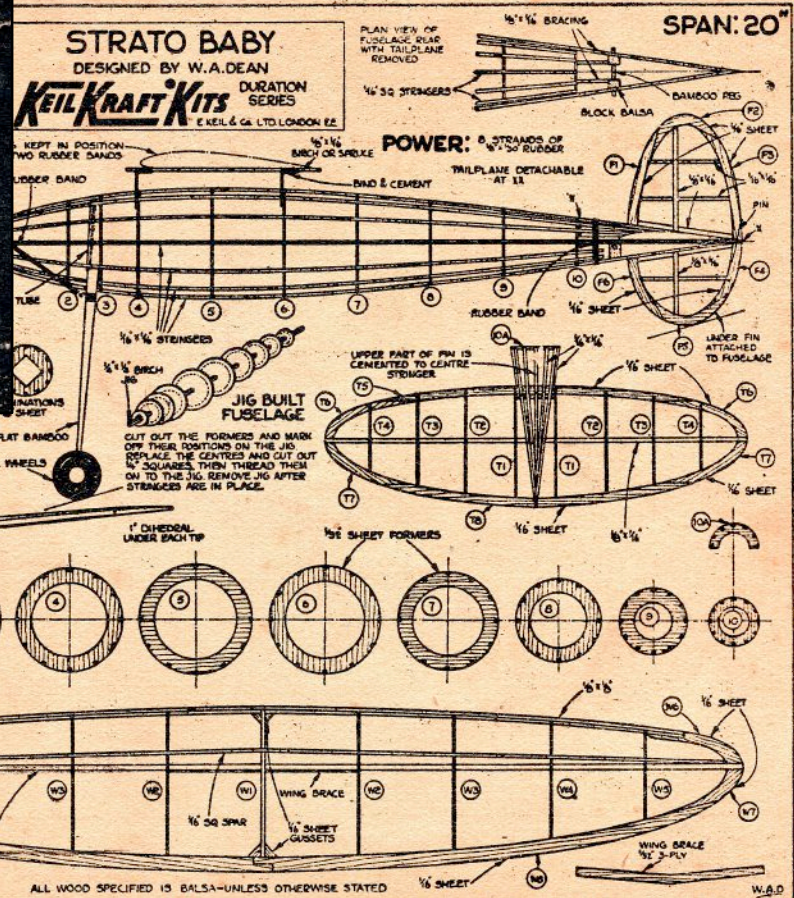

PETROL MODELS.
RUBBER LUBRICANT.
A few drops on your motor will enable you to pack in hundreds of extra turns.
RUBBER.
Super power black rubber in three sizes, 1/8" flat, 1/4" flat and 1/16" flat.
DOPE.
Packed in 1 oz. and half pint tins. White, Yellow, Red, Black, Orange, Green, Light and Dark Blue and clear.
COVERING MATERIALS.
Tissues in all colours.
PIANO WIRE.
10, 12, 14, 16, 18, and 20 S.W.G., in 36" lengths.
BALL RACES.
By using one of these races in place of regular washers, friction is almost entirely eliminated.

BRASS TUBE.
16, 18 and 20 S.W.G., in 12" lengths.
ALUMINIUM TUBE.
16, 18 and 20 S.W.G., in 12" lengths.

BRASS BUSHES.
Screwed and plain — 16, 18, and 20 S.W.G.

SOLID MODEL ACCESSORIES.
COCKPIT COVERS.
60 different types to 1/48 and 1/72 scale.

WOODEN WHEELS.
(turned one side).
1/2", 3/4" and 1".

PLASTIC WHEELS.
3/4", 1", and 1 1/4".

SPINNERS.
1/72 scale wooden type.
ENGINE COWLS.
1/72 scale wooden type.
METAL PROPELLERS.
3 and 4 bladed to 1/72 scale.

TRANSFERS.
● Sets for British, American and German models. New and old type insignia for both fighter and bomber aircraft.
● Alphabets in 1/8", 1/4", 3/8", 1/2" and 3/4" sizes. (Red, Black, Yellow and Blue)

FLYING PROPELLERS.
Hard grained balsa type — in 14 sizes (5" to 18").
BALSA KNIFE.
A razor-edge blade securely fastened in a long easy grip handle. Cuts balsa like butter.
MISCELLANEOUS.



*** STOP PRESS ***

NEW BRITISH RECORD

As we go to press a very tired Brian Lever has been in touch to say that he and the team have made the attempt on the British flying electric control line models for 24 hours from two circles on the 21-22 June 2021.

“The British Record is secured! We managed to have achieved an airtime of nearly 28 hours as the clock struck 10.00 the following morning.”

Not only is this a new record but money has been raised for St Pega’s Church in the Cambridgeshire village of Peakirk to

replace the lead roof that was stolen. It is not too late to donate to this endeavour, go to Brian’s page on the Just Giving charity site

www.justgiving.com/fundraising/Brian-Lever

Brian will give us a full report next month.

The British record setters flew at Peakirk Village Green, which is adjacent to St Pega’s Church, to enable the local community to become involved.



8 AeroModeller 1011 - August 2021

RC Top 10 Leader Boards 2021

The purpose of the Vintage SIG RC Leader Boards is to increase enjoyment of competition flying by showing fliers how well they are performing relative to others. Scores are posted from the results of contests, NDC, and independently-timed flying.

The Leader Boards run for each calendar year, and are updated throughout. At the end of each year they are cleared and started afresh. The record for each class is maintained over time, and shown in blue italics with the year in which it was set.

The new postings are mostly from NDC flying. There are excellent new scores in Vintage E Duration, and Allan Knox has set an amazing new record in Vintage Precision.

Please email me if you spot any errors or omissions.

Wayne Cartwright
 rwcartwright4@gmail.com

Standings at 22 September

Precision Classes

Vintage Precision

Record: A Knox (2021) 600 + 200 + 200 + 194

1.	A Knox	600 + 200 + 200 + 194
2.	B Russell	600 + 199
	B Robinson	600 + 199
4.	B Treloar	600 + 198
5.	D Mossop	600 + 193
6.	D Crook	600 + 192
7.	L King	600
8.	T Gribble	599
	J Ryan	599
10.	M Larsen	596

Classical Precision

Record: A Knox (2021) 599

1.	A Knox	599
2.	M Shears	590
3.	B Robinson	589
4.	B Russell	575
5.	D Mossop	570
6.	G Main	553
	D Thornley	553
8.	G Fulton	548
9.	S Nicholas	538
10.	B Scott	391

Duration Classes

Vintage IC Duration

Record: S. Cox (2019) 780 + 500 + 391

1.	A Knox	780 + 359
2.	A Knox	773
3.	T Beaumont	764
4.	D Thornley	757
5.	S Cox	703
6.	J Miller	655
7.	J Ryan	589
8.	B Russell	575
9.	R Anderson	515
10.	D Little	495

Vintage E Duration

Record: B Harris (2018) 960 + 600

1.	B Russell	950 + 559
2.	S Nicholas	950 + 481
3.	A Knox	960 + 404
4.	R Nimmo	946
5.	D Mossop	914
6.	B Robinson	877
7.	W Cartwright	639
8.	M Larsen	571
9.	B Scott	535
10.	R Anderson	521

Classical IC Duration

Record: D Thornley (2017) 900 + 600

1.	B Scott	539
2.	D Thornley	514

Classical E Duration

Record: W Cartwright (2018) and B Russell (2019) 900 + 600

1. B Russell	900 + 299
2. B Robinson	891
3. D Gush	875
4. A Knox	853
5. W Cartwright	825
6. P Townsend	772
7. M Shears	741
8. D Mossop	713
9. J Miller	712
10. D Crook	694

4. S McCurrie	1643
5. S Grant	1395
6. T Glogau	1218
7. B Scott	1138
8. S Cox	1028
9. J Butcher	614

Vintage Open Texaco

Record: B Treloar (2018) 1840 + 1703

1. B Scott	1830
2. A Knox	1828
3. B Treloar	1586
4. B Russell	744
5. I Munro	686
6. S McCurrie	162

Vintage E Texaco

Record: A Knox (2020) 3000

1. D Crook	2793
2. W Cartwright	2317
3. B Russell	1735
4. A Knox	1600
5. J Butcher	1450
6. T Gribble	1427
7. B Scott	1388
8. B Robinson	1340
9. D Mossop	1188
10. R Anderson	1170

Vintage E Rubber Texaco

Record: B Russell (2019): 5685

1. J Butcher	4570
2. D Mossop	3835
3. D Crook	2688
4. B Russell	2687
5. J Danks	2588
6. K Fisher	2037
7. T Gribble	2026
8. S Nicholas	1857
9. A Knox	1566
10. D Gush	1268

Texaco Classes

Vintage 1/2A Texaco

Record: A Knox (2018) 1500 + 1833

1. A Knox	1500 + 622
2. L Rodway	1489
3. B Treloar	1416
4. S Cox	1363
5. B Scott	1240
6. P Townsend	1239
7. S Morse	1233
8. D Gush	1222
9. J Ryan	1110
10. S Grant	1025

Vintage 1/2E Texaco

Record: P Townsend (2020) 3689

1. W Cartwright	2839
2. J Butcher	2388
3. K Fisher	1964
4. T Gribble	1624
5. B Russell	1390
6. B Robinson	1387
7. L Rodway	1362
8. B Scott	1313
9. A Knox	884

Vintage A Texaco

Record: A Knox (2018) 1860 + 1870

1. B Treloar	1860 + 669
2. A Knox	1852
3. B Treloar	1844

Classical 1/2E Texaco

Record: D Crook (2020) 2774

1. T Gribble	1482
2. D Crook	1437
3. W Cartwright	637

Classical E Texaco

Record: A Knox (2020) 3310

1. D Mossop	2697
2. A Knox	2291
3. P Townsend	1857
4. K Fisher	1636
5. B Russell	1335
6. T Gribble	1219
7. B Scott	804
8. D Thornley	512

Sport Cabin Texaco E

Record: K Trillo (2019) 4457

1. K Fisher	3116
2. J Butcher	2382
3. B Scott	1779
4. R Anderson	1422
5. B Russell	1243
6. P Townsend	1222
7. M Evans	1134
8. B Robinson	956
9. L Rodway	909

Sport Cabin Texaco IC

Record: S McCurrie (2021) 1646

1. S McCurrie	1646
2. A Knox	1427
3. J Beresford	543
4. L Rodway	452
5. B Scott	324

Vintage and Classical Scale Texaco

Record: A Knox (2020) 1680 + 786

1. A Knox	1680 + 771
-----------	------------

RADIO CONTROL and Model Aircraft WORLD

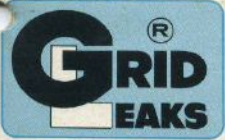

VOL. 7, NO. 4 JULY-AUGUST 1966 35 CENTS

IN THIS ISSUE

- The Stits Skycoupe—A Real Beauty
- R/C Makes Slotless Racing Possible
- More Muscle for the Adams Actuator

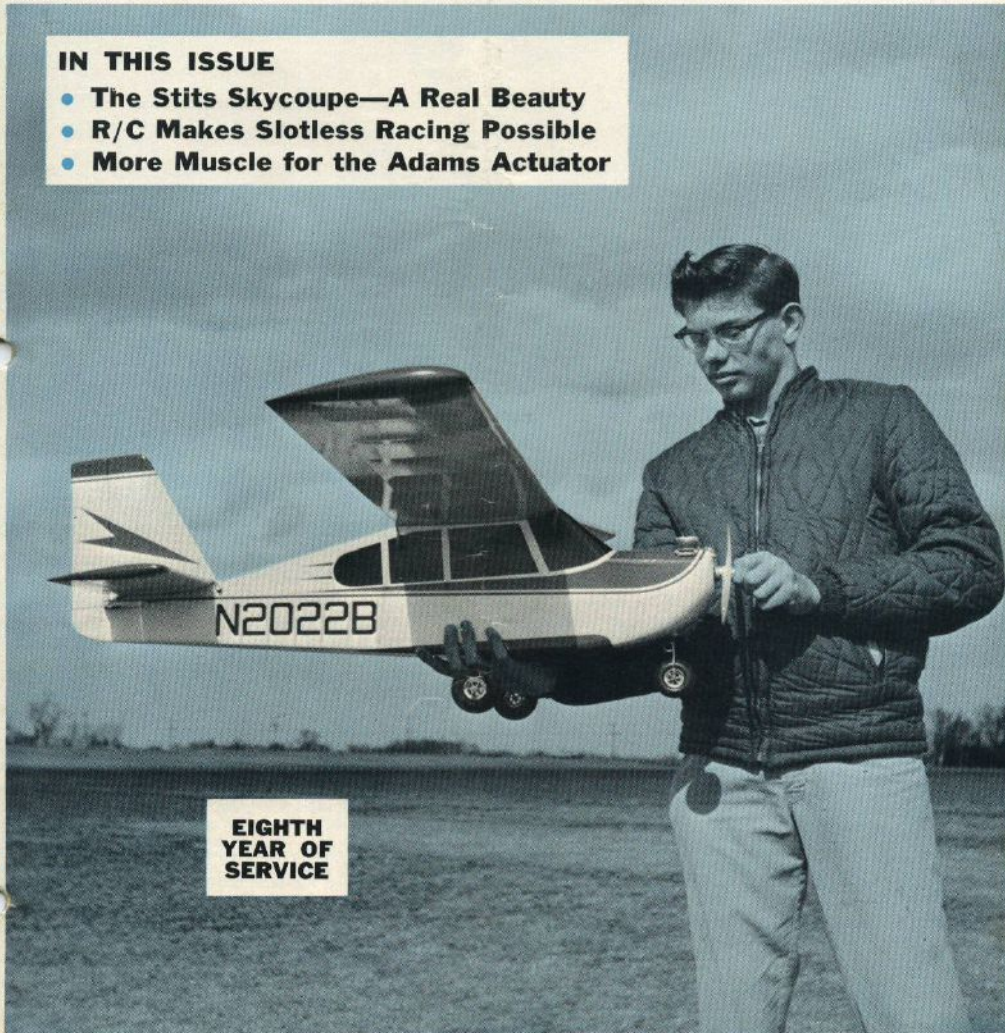

EIGHTH
YEAR OF
SERVICE

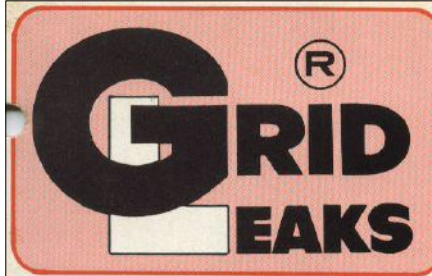

Radio Control World

Vol. 7 No. 5 September-October 1966 35 cents

THE WILD ONE!



Add-on Switcher for Motors
Jim Kirkland's SACS
Installing R C in a Sailboat

EIGHT YEARS OF SERVICE



Merrill Hamburg *knows* model airplanes.

✦ 2021 AMA Nats Winners

AMA Catapult Glider – Rocco Ferrario Designs: Hoosier Kitty (Bruce Kimball) and Papanui Tavern (Paul Lagan)

I used my 2014 winner (Hoosier Kitty) for the first two maxes but was not happy with the glide. Switched to my Papanui Tavern for the last three maxes.

NZ ICON #186 **CHOCOLATE FISH**

In New Zealand, the chocolate fish is a popular confectionery. Several manufacturers make the fish, but the most well-recognised is Cadbury.



In NZ culture, giving a chocolate fish is a jocular reward for a job done well - "*Give that man a chocolate fish!*"

Chocolate fish have a conventional fish-shape and a length of 5 to 10 centimetres. Smaller variants are referred to as "sprats".

They are made of pink or white marshmallow covered in a thin layer of milk chocolate with scale-like ripples created by the fish moving under a blower while the chocolate is hot.

